

N & P CHANNEL LATERAL POWER MOSFET FOR AUDIO

ALF08NP16V5/ALF08NP20V5

- Complimentary N & P Channel devices in a single package
- Designed specifically for linear audio amplifier applications
- High-speed for high bandwidth amplifiers
- High voltage rating – 160V & 200V
- 5 pinTO-247 package

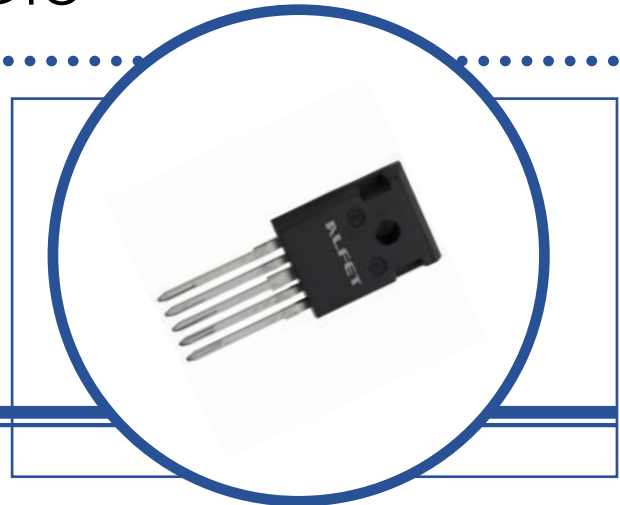

ABSOLUTE MAXIMUM RATINGS

($T_C = 25^\circ\text{C}$ unless otherwise stated)

		ALF08NP16V5	ALF08NP20V5
V_{DSS}	Drain - Source Voltage	$\pm 160\text{V}$	$\pm 200\text{V}$
V_{GSS}	Gate - Source Voltage		$\pm 20\text{V}$
I_D	Continuous Drain Current		$\pm 8\text{A}$
I_{DR}	Body Drain Diode Current		$\pm 8\text{A}$
P_D	Allowable Power Dissipation $T_{\text{case}} = 25^\circ\text{C}$		TBC
T_{ch}	Channel Temperature		150°C
T_{stg}	Storage Temperature Range		-55 to $+150^\circ\text{C}$

THERMAL PROPERTIES

Symbols	Parameters	Min.	Typ.	Max.	Units
$R_{\theta JC}$	Thermal Resistance, Junction To Case			TBC	$^\circ\text{C/W}$

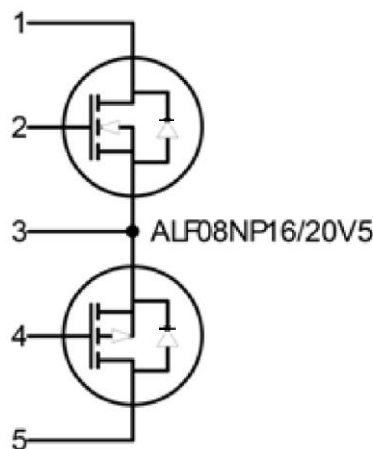

Magnatec reserves the right to change test conditions, parameter limits and package dimensions without notice. Information furnished by Magnatec is believed to be both accurate and reliable at the time of going to press. However Magnatec assumes no responsibility for any errors or omissions discovered in its use. Magnatec encourages customers to verify that datasheets are current before placing orders.



A subsidiary of
TT electronics plc.

ELECTRICAL CHARACTERISTICS ($T_C = 25^\circ\text{C}$ unless otherwise stated) (N-channel values stated, values negative for P-Channel)

Symbols	Parameters	Test Conditions	Min.	Typ	Max.	Units
BV_{DSX}	Drain-Source Breakdown Voltage	$V_{GS} = -10\text{V}$	ALF08NP16V	160		V
		$I_D = 10\text{mA}$	ALF08NP20V	200		
I_{GSS}	Gate-Source Leakage Current	$V_{DS} = 0$ $V_{GS} = \pm 20\text{V}$			100	μA
$V_{GS(\text{off})}$	Gate-Source Cut-off Voltage	$V_{DS} = 10\text{V}$ $I_D = 100\text{mA}$	0.15		1.5	V
$V_{DS(\text{sat})}^*$	Drain-Source Saturation Voltage	$V_{GD} = 0$ $I_D = 8\text{A}$			12	V
$ y_{fs} ^*$	Forward Transfer Admittance	$V_{DS} = 10\text{V}$ $I_{DS} = 3\text{A}$	0.7		2	$S(\Omega)$
I_{DSX}	Drain-Source Cut-Off Current	$V_{GS} = -10\text{V}$	$V_{DS} = 160\text{V}$ ALF08NP16V		10	mA
			$V_{DS} = 200\text{V}$ ALF08NP20V		10	

* Pulse Test: Pulse Width = 300 μs , Duty Cycle $\leq 2\%$

DYNAMIC CHARACTERISTICS

Symbols	Parameters	Test Conditions	N-Ch Typ.	P-Ch Typ.	Units
C_{iss}	Input Capacitance	$V_{GS} = 0$	500	700	pF
C_{oss}	Output Capacitance	$V_{DS} = 10\text{V}$	300	300	
C_{rss}	Reverse Transfer Capacitance	$f = 1.0\text{MHz}$	10	25	
t_{on}	Turn-On Time	$V_{DS} = 20\text{V}$	100	120	ns
t_{off}	Turn-Off Time	$I_D = 5\text{A}$	50	60	

Please Note: These lateral mosfets do not include a G-S protection network and care must therefore be taken with static handling precautions and the appropriate protection in the amplifier circuit. Please refer to the application notes for more information.

N-CHANNEL GENERAL CHARACTERISTICS ($T_C = 25^\circ\text{C}$ unless otherwise stated)

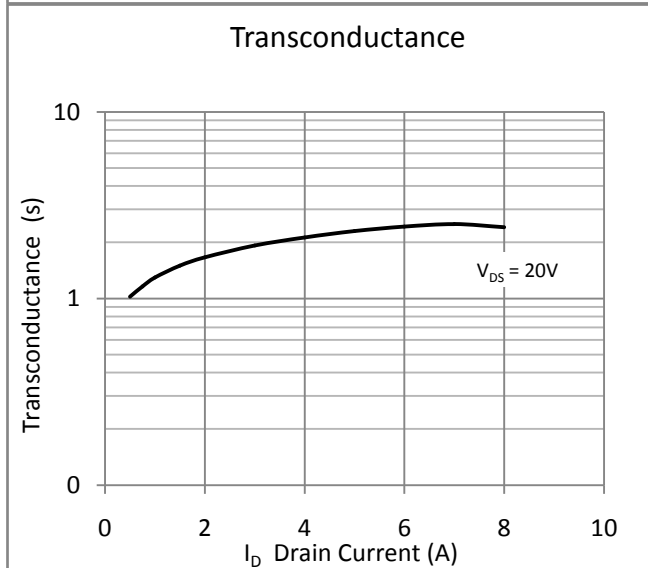
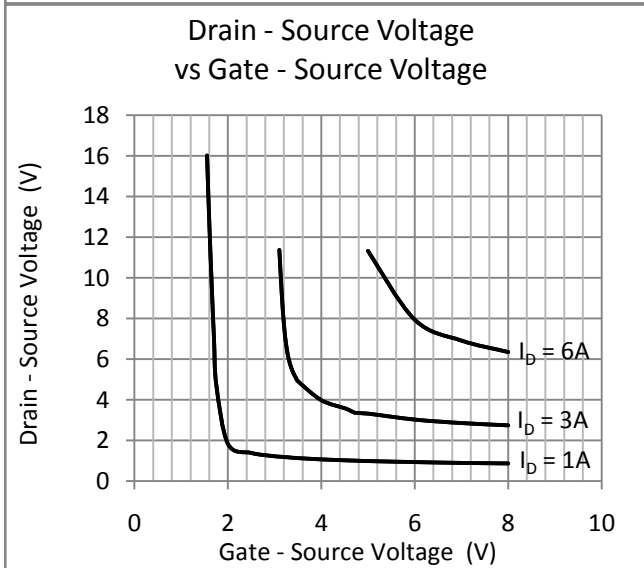
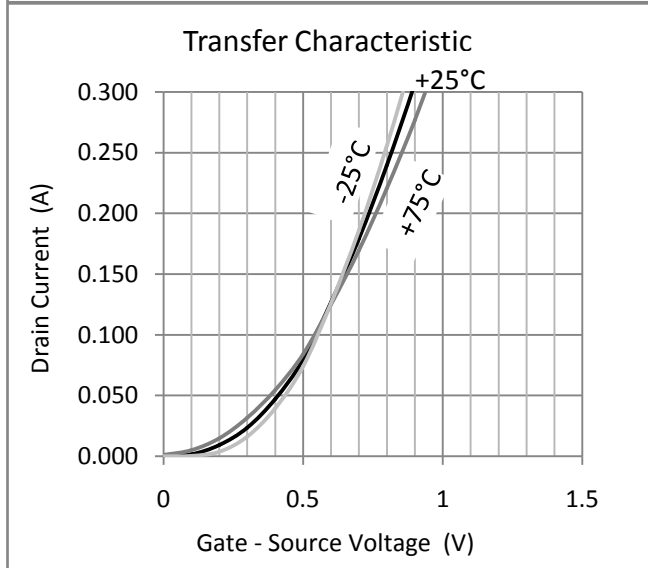
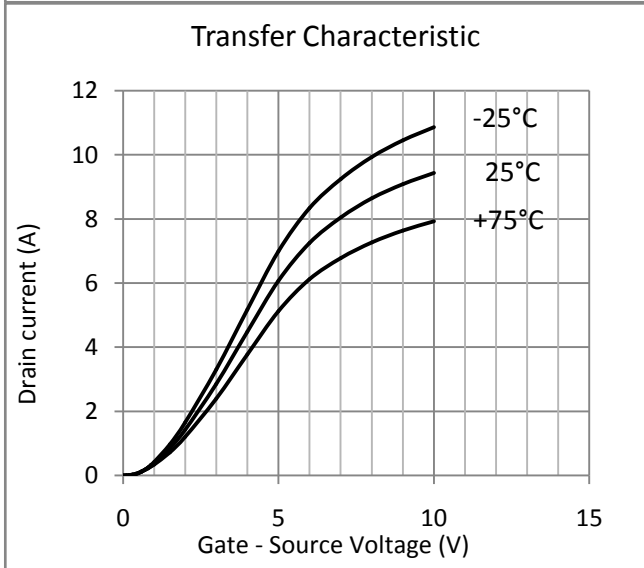
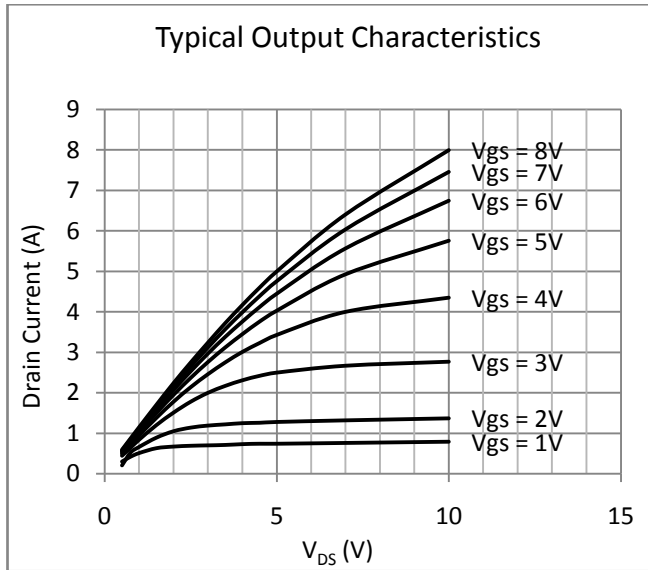
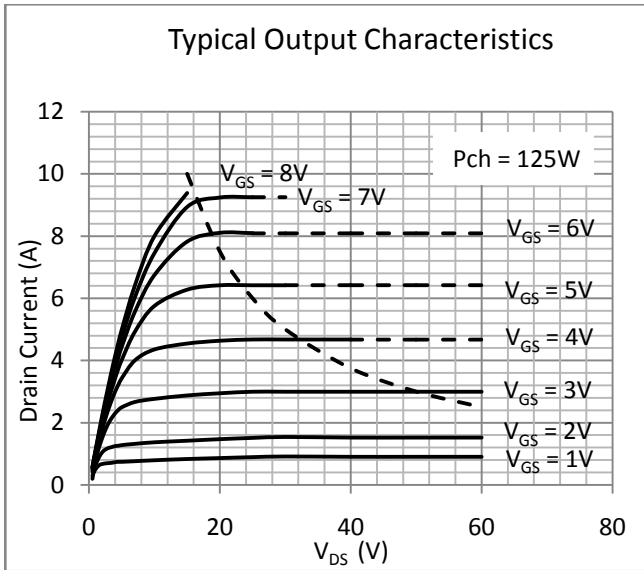

N-CHANNEL GENERAL CHARACTERISTICS CONTINUED

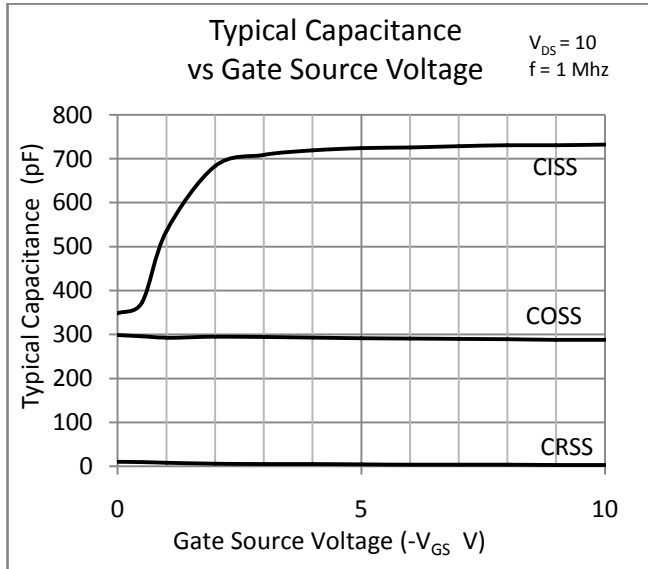
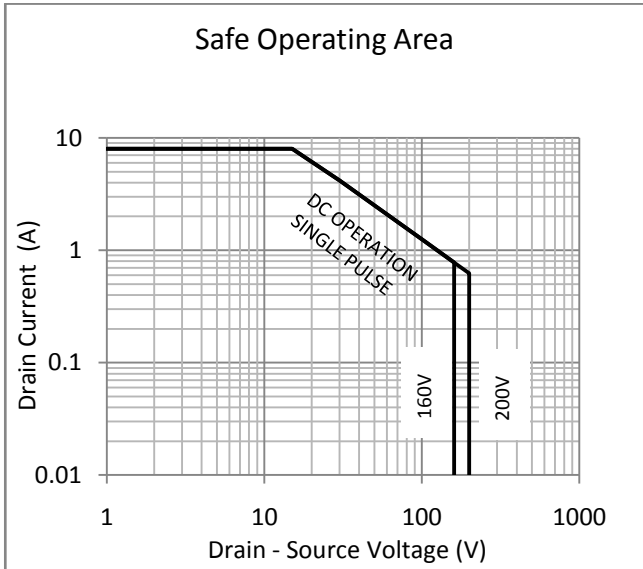

P-CHANNEL GENERAL CHARACTERISTICS ($T_C = 25^\circ\text{C}$ unless otherwise stated)

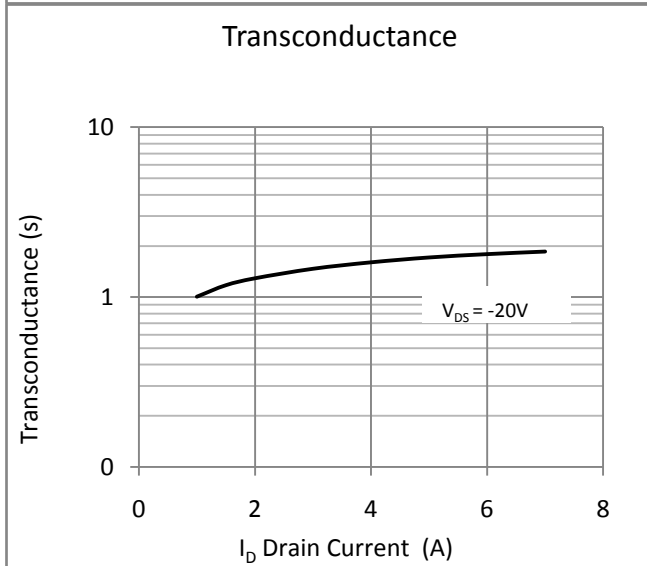
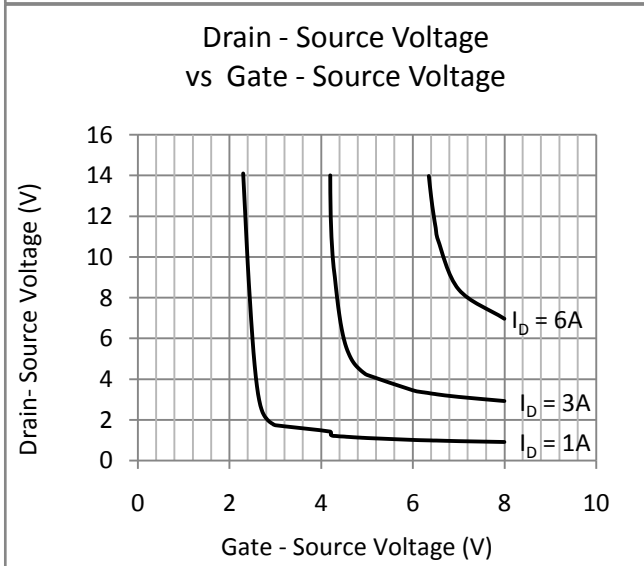
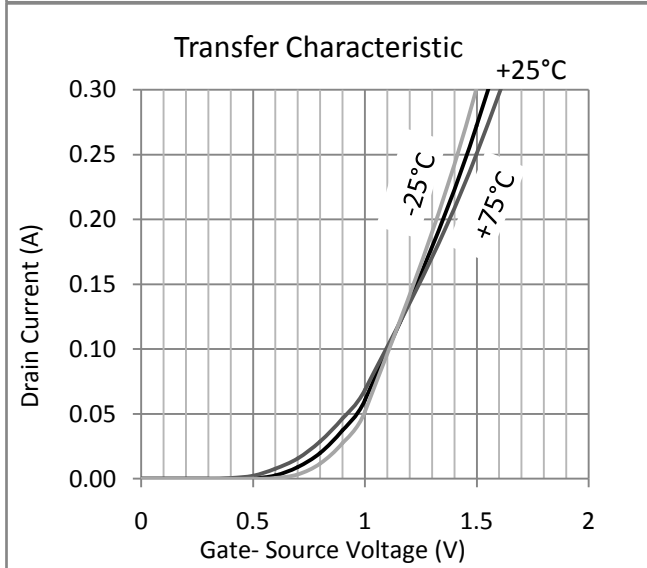
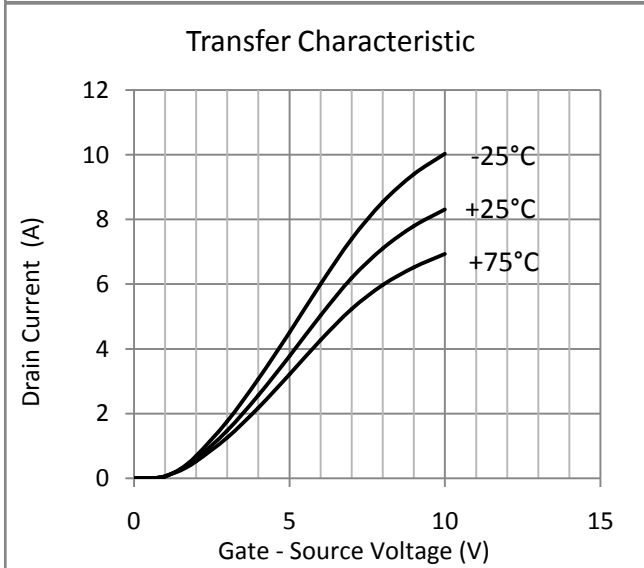
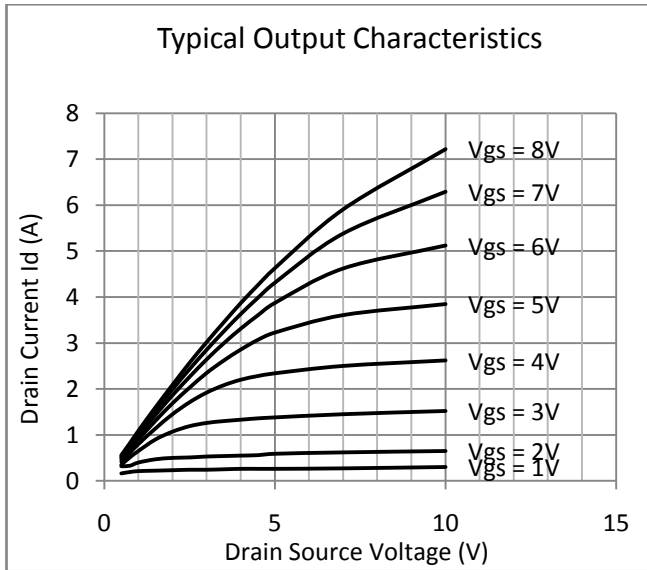
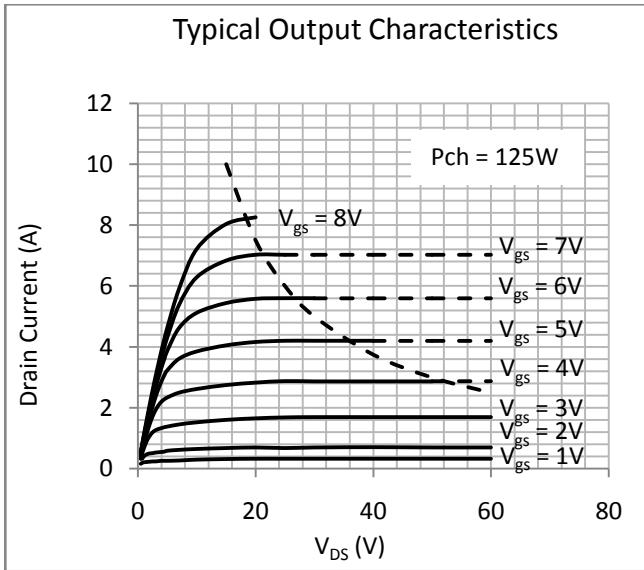

P-CHANNEL GENERAL CHARACTERISTICS CONTINUED

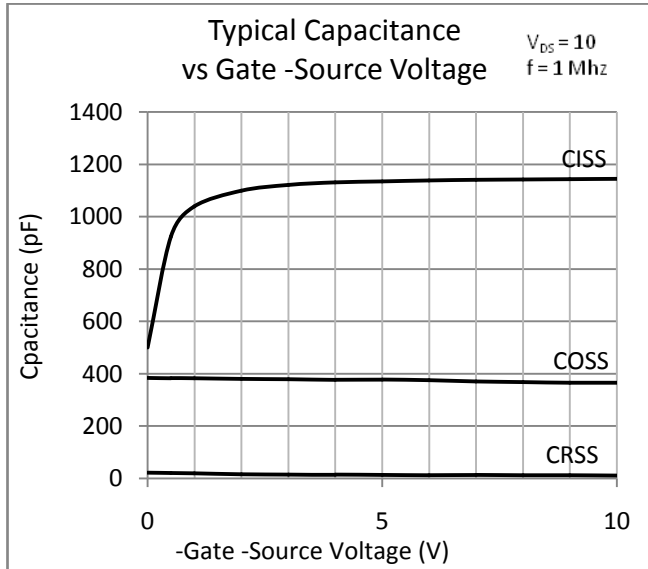
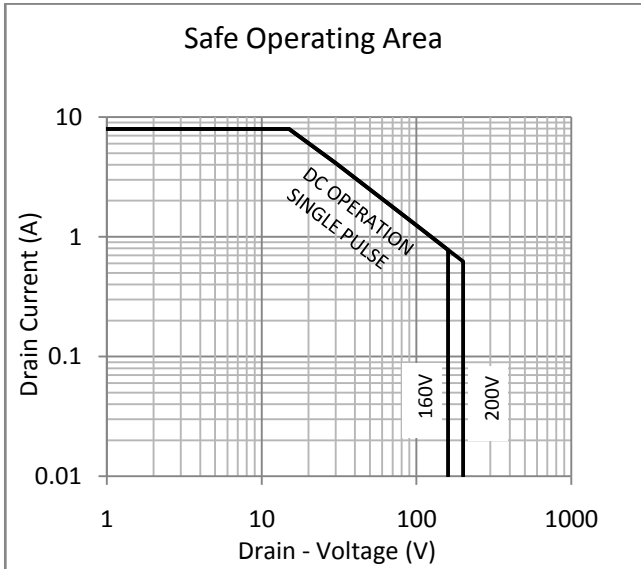

MECHANICAL DATA

Dimensions in Inches (mm)

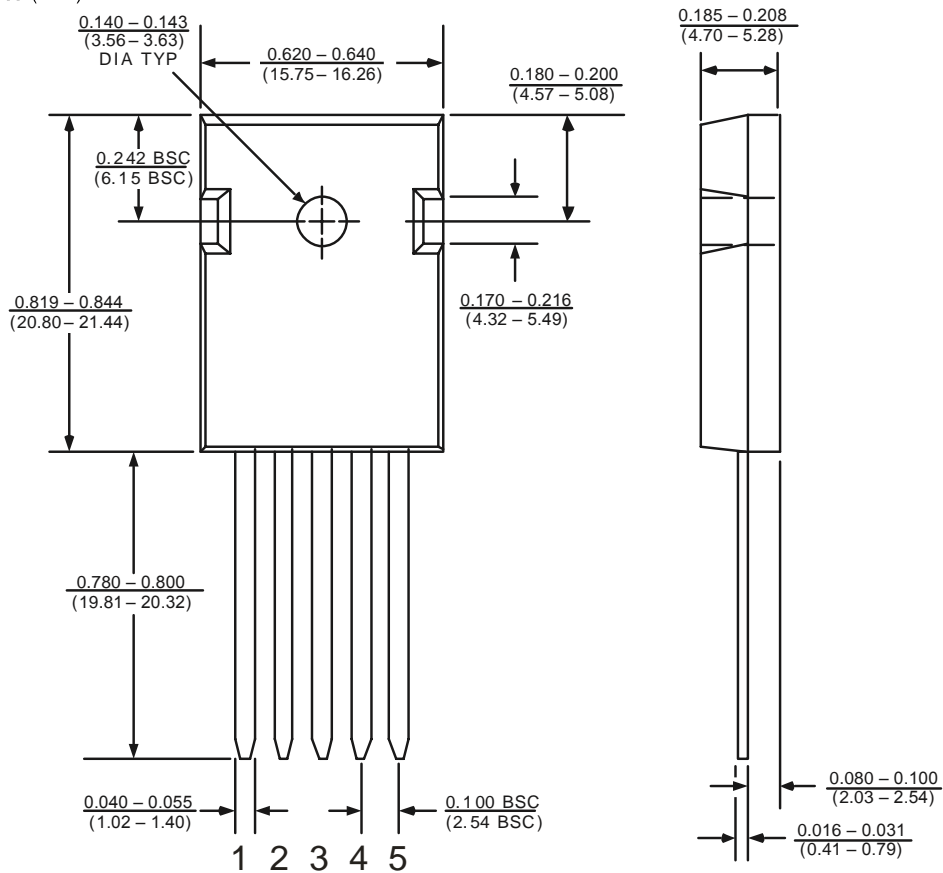

TO-247-5L

Pin1 – N-Ch Drain

Pin2 – N-Ch Gate

Pin3 – Source(common)

Pin4 – P-Ch Gate

Pin5 – P-Ch Drain