

TESTER
POLPRZEMODNIKOM ver.2

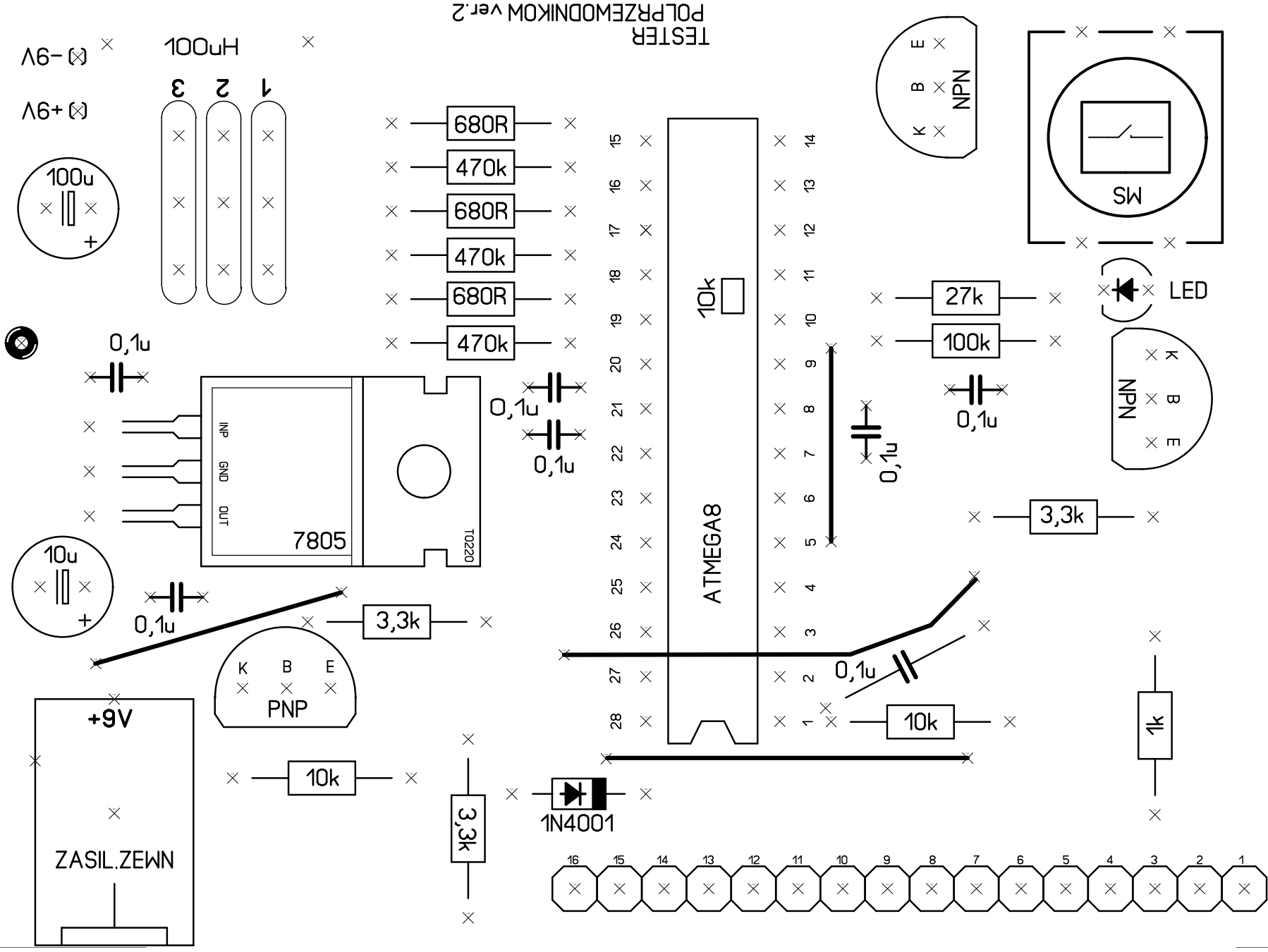

MC1602A0

TESTER
POLPRZEMODNIKOW ver.2

WC1602A0

V6-9V ⊖
V6+9V ⊕

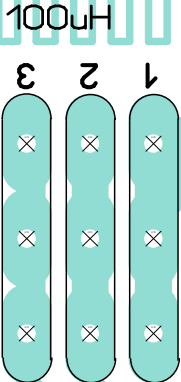

0,1u

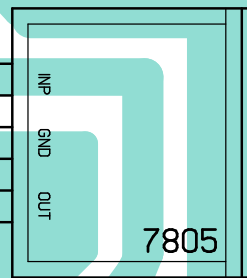

T0220



0,1u

3,3k

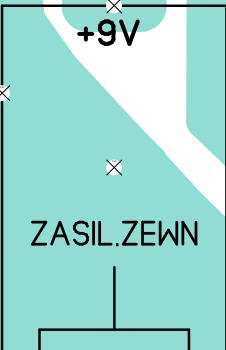
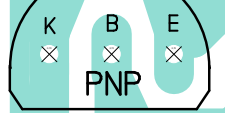

10k

3,3k



1N4001

3,3k

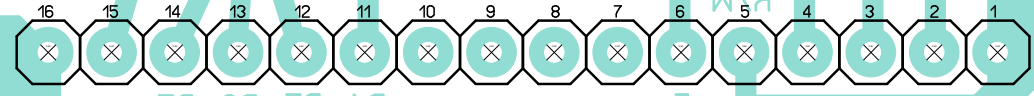

D4 D2 D8 D5 E R5 R4 R3 R2 R1

680R
470k
680R
470k
680R
470k

10k

ATMEGA8

0,1u
0,1u

0,1u

27k
100k

0,1u

3,3k

10k

1k

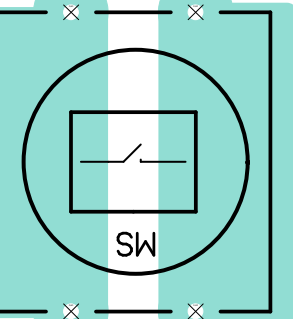
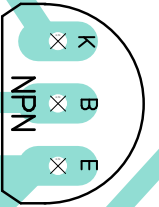

LED

